



# WATER PRICELIST 2023

Intelligent eco solutions

**roto**  
since 1949



Roto, an international company based in Murska Sobota, specialises in the production of plastic mass. The roots of the family-run business go back to 1949. ROTO employs more than 500 people in 7 factories located in 4 countries.

Roto generated revenues of €63 million in 2020, selling products in 63 countries around the world.

Roto is Europe's leading rotomoulding company, producing more than 4,000 different products. The company's development is ensured by continuous innovation, new technologies and materials that ROTO develops with scientific institutes, universities and other companies.

The Roto-branded product groups are divided into four segments: products for agriculture, garden, sport and ecology. The use of composites and biodegradable and recycled polymers enables the production of the most complex products on the market.



EY world  
family award

Roto also manufactures a wide range of readymade products for various industries such as automotive, marine, construction and agricultural machinery, aquaculture and logistics. Added value comes from innovative design, the use of intelligent polymers and composites, and state-of-the-art manufacturing.

Covers and extensions 5



RoSeptic 6



RoEco 7



EcoBlue 7



Waste water treatment plants

EcoBox 8



RoClean 9



Spare parts 14



Additional equipment 12



RoTerra 15



RoBox 17

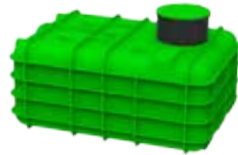

RoCko 18



RoDrink 21



Water tanks

RoSep 23



RoPetrol 24



RoOil 27



RoOil 27



Oil separators

RoGra 28



RoFett 28



RoGre 28



RoMast 28



Grease separators

RoPump 29



Salt box 31



Plastic urn 31



Watermeter shaft 31



Pumping stations

Drainage shaft 32



Calming shaft 32



Sand shaft 32



Additional equipment 33



Shafts

Waste water treatment plants

Water tanks

Oil separators

Grease separators

Pumping stations

Shafts



ROTO and its technical team provide you with comprehensive support from the start of the project to the management of the facility. ROTO's smart water management solutions include a full range of services, from project development, design and engineering to procurement of system components and project management through technical operations and maintenance. We can also prepare all the necessary project documentation for you.

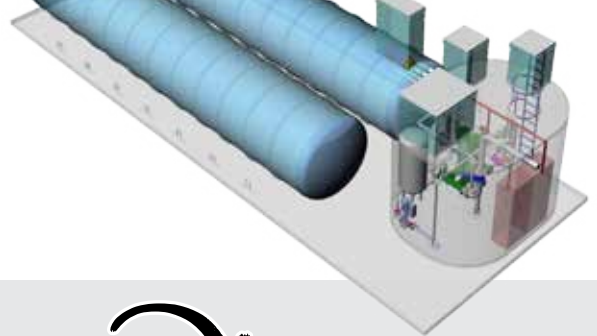

Check the existing input data



Visit the construction site

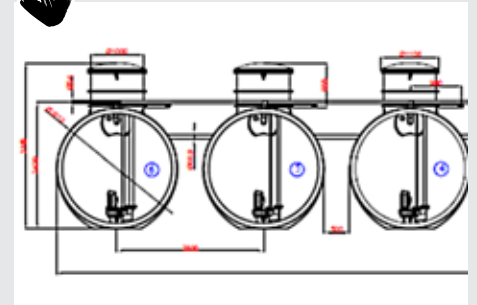

Searching the optimal technical solution

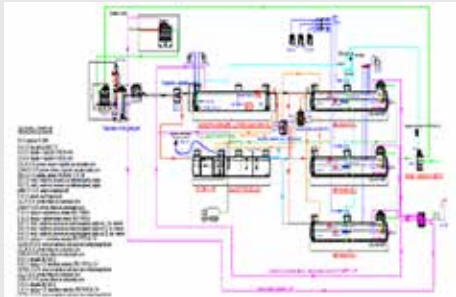

Project management, obtaining the required building approvals



Installation of products and hand over the required technical documentation



Operation and maintenance





H-Cover	Type	Code	EAN	Dim. (mm)	Price (€)
Hinged cover DN600, PE with adapter	H6	7100520370	3831116157558	Ø600	133
Hinged cover DN800, PE with adapter	H8	7100520620	3831116126509	Ø855x130	190
Hinged cover DN1000, PE with adapter	H10	7100520970	3831116135174	Ø1135x160	290



S-Cover	Type	Code	EAN	Dim. (mm)	Price (€)
Screw down cover DN400, PE	S4	0006636	3830043918058	Ø400	30
Screw down cover DN600, PP	S6-PP	1280272		Ø600	53
Screw down cover DN600, PE	S6	7200520190	3831116120323	Ø600	53
Screw down cover DN800, PE	S8	7100901810	3830050778201	Ø800	90



T-Cover	Type	Code	EAN	Dim. (mm)	Price (€)
Threaded cover DN400, PE	T4	0006171	3830010989715	Ø400	30
Threaded cover DN500, PE	T5	7104111660	3831116144909	Ø500	35
Threaded cover DN600, PE	T6	0007300	3830043917594	Ø600	40



IC-Cover	Type	Code	EAN	Dim. (mm)	Price (€)
Cover RoPetrol DN600, cast iron, with frame	IC6	1280431		Ø600	290



Adapter	Type	Code	EAN	Dim. (mm)	Price (€)
Adapter for screw down cover, DN600	S6	7100520310	3831116121702	Ø600	80



TH-Extension	Type	Code	EAN	Dim. (mm)	Price (€)
Threaded telescopic extension DN600 x 400 with cover	TH6x4	7600088710	3831116136683	Ø600 x 400	176

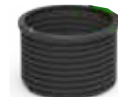

TS-Extension	Type	Code	EAN	Dim. (mm)	Price (€)
Screw down telescopic extension DN600 x 500	TS6x5	7113110690	3830050770007	Ø600 x 500	130
Screw down extension DN800 x 700	S8x7	7100067020	3830050771158	Ø800 x 750	150



TS-Extension	Type	Code	EAN	Dim. (mm)	Price (€)
Extension of extension telescopic DN600 x 600	TS6x6	7113110700	3830050777167	Ø600 x 600	130



O-Extension	Type	Code	EAN	Dim. (mm)	Price (€)
Extension oktabin DN600	O6	7100520320	3831116147085	Ø620 x 700	120



T-Extension	Type	Code	EAN	Dim. (mm)	Price (€)
Threaded extension DN400 x 200	T4x2	0006358	3830010986288	Ø400 x 200	45
Threaded extension DN600 x 200	T6x2	0006357	3830010986349	Ø600 x 200	90
Threaded extension DN600 x 250	T6x2,5	7100520630	3831116147351	Ø600 x 250	90
Threaded extension DN600 x 500	T6x5	7100520640	3831116147368	Ø600 x 500	120



C-Extension	Type	Code	EAN	Dim. (mm)	Price (€)
Cylinder extension DN600	C6	7700000020	3831116163238	Ø600 x 750	175
Cylinder extension DN800	C8	7106548710	3831116162460	Ø800 x 750	220
Cylinder extension DN1000	C10	7106548720	3831116162477	Ø1000 x 750	350

In the year 2022 we have developed a broad range of covers and extensions for different applications. From 1.1..2023 all covers and extensions are sold separately and are no longer included in the price of the tank.



RoSeptic 2-chamber

RoSeptic 3-chamber

Product	Code	EAN	Dimesion (mm)	Cover	Price (€)
1.000 L RoSeptic, 2-chamber	7500063619	3830010985830	1580 x 1060 x 1000-1380	2 x T4	1.040
2.200 L RoSeptic, 2-chamber	7500067619	3831116116883	1840 x 1400 x 1600-1930	TH6 x 4	1.290
2.600 L RoSeptic, 2-chamber	7500067389	3831116158364	2150 x 1400 x 1600-1930	TH6 x 4	1.380
3.000 L RoSeptic, 2-chamber	7500063609	3830010985908	2400 x 1400 x 1600-1930	TH6 x 4	1.450
3.500 L RoSeptic, 2 - chamber	7500063309	3830050770182	2080 x 1800 x 2050-2550	TH6 x 4	1.750
5.000 L RoSeptic, 2-chamber	7500062399	3830010985915	2450 x 1800 x 2050-2550	TH6 x 4	1.860
6.000 L RoSeptic, 2 - chamber	7500063289	3831116109014	2820 x 1800 x 2050-2550	TH6 x 4	2.280
8.000 L RoSeptic, 2-chamber	7500062559	3830010987230	2680 x 2300 x 2350-2850	2 x TH6 x 4	3.360
10.000 L RoSeptic, 2-chamber	7500690319	3831116128152	3040 x 2300 x 2350-2850	2 x TH6 x 4	3.580
12.000 L RoSeptic, 2-chamber	7500062519	3830010986783	3760 x 2300 x 2350-2850	2 x TH6 x 4	3.950
16.000 L RoSeptic, 2-chamber	7500066199	3831116116913	4840 x 2300 x 2350-2850	2 x TH6 x 4	4.640
20.000 L RoSeptic, 2-chamber	7500062589	3831116153376	4540 x 2420 x 2800-3100	2 x TH6 x 4	5.940
25.000 L RoSeptic, 2-chamber	7500062609	3831116153390	5720 x 2420 x 2700-3000	2 x TH6 x 4	7.000

Product	Code	EAN	Dimesion (mm)	Cover	Price (€)
5.000 L RoSeptic, 3-chamber	7500063629	3830010985922	2450 x 1800 x 2050-2550	TH6 x 4+S4	2.230
6.000 L RoSeptic, 3-chamber	7500063299	3830050770205	2820 x 1800 x 2050-2550	TH6 x 4+S4	2.650
8.000 L RoSeptic, 3-chamber	7500062569	3830010986493	2680 x 2300 x 2350-2850	2 x TH6 x 4	4.000
10.000 L RoSeptic, 3-chamber	7500690329	3831116128169	3040 x 2300 x 2350-2850	2 x TH6 x 4	4.220
12.000 L RoSeptic, 3-chamber	7500062539	3830010986790	3760 x 2300 x 2350-2850	2 x TH6 x 4	4.590
16.000 L RoSeptic, 3-chamber	7500066209	3831116116920	4840 x 2300 x 2350-2850	2 x TH6 x 4	5.280
20.000 L RoSeptic, 3 -chamber	7500062589	3831116153383	4540 x 2420 x 2700-3100	2 x C8+H8	7.100
25.000 L RoSeptic, 3 -chamber	7500062609	3831116153406	5720 x 2420 x 2700-3000	3 x TH6 x 4	8.160



RoEco



EcoBlue



RoMem

Product	Volume	Max day inflow	Code	EAN	Dimension (mm)	Cover	Price (€)
3 PE RoEco	3.200 L	0,45 m <sup>3</sup>	7200068109	3831116121825	Ø1800 x 2050	H8	3.380
5 PE RoEco	4.000 L	0,7 m <sup>3</sup>	7200063809	3830043917211	Ø1800 x 2400	H8	3.590
8 PE RoEco	6.000 L	1,2 m <sup>3</sup>	7200063819	3830043917228	Ø2300 x 2300	H8	5.170

Product	Volume	Max day inflow	Code	EAN	Dimension (mm)	Cover	Price (€)
<b>NEW</b> 4 PE EcoBlue	4.000 L	0,9 m <sup>3</sup>	7200079819	3831116149263	2330 x 1175 x 1950-2280	2 x TH6 x 4	4.540
<b>NEW</b> 8 PE EcoBlue	6.000 L	1,5 m <sup>3</sup>	7200079779	3831116153321	2450 x 1350 x 2520-2720	2 x TH6 x 4	6.770

Product	Volume	Max day inflow	Code	EAN	Dimension (mm)	Cover	Price (€)
4 PE RoMem	4.000 L	0,6 m <sup>3</sup>	7200088809	3831116114865	2330 x 1175 x 2440	2 x TH6 x 4	6.890
6 PE RoMem	6.000 L	0,9 m <sup>3</sup>	7200088819	3831116129333	2450 x 1350 x 2775	2 x TH6 x 4	8.780

Waste water treatment plants

Water tanks

Oil separators

Grease separators

Pumping stations

Shafts

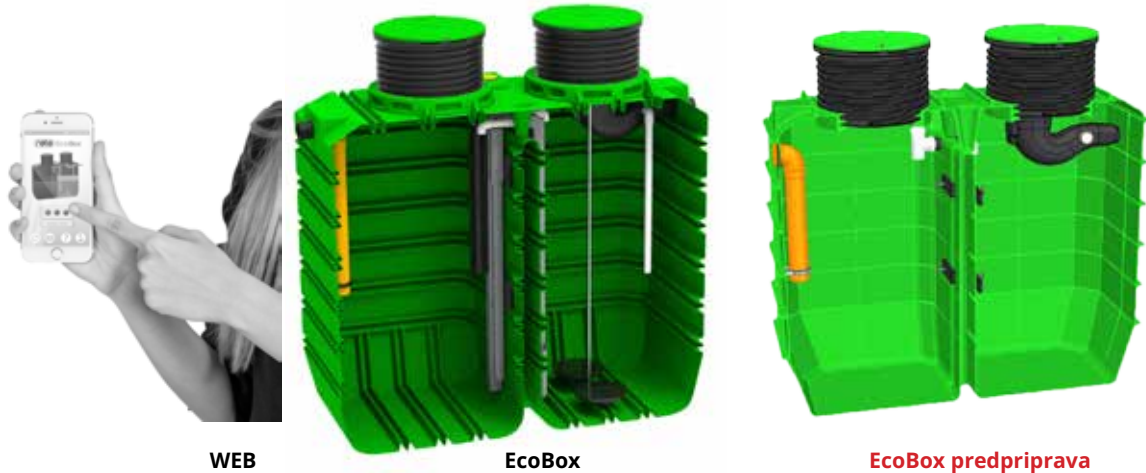

WEB

EcoBox

EcoBox predpriprava

Product	Volume	Max day inflow	Code	EAN	Dimension (mm)	Cover	Price (€)
2 - 5 PE EcoBox	4.000 L	0,75 m <sup>3</sup>	7200079959	3830050775804	2330 x 1175 x 2440	2 x TH6 x 4	3.980
6 - 9 PE EcoBox	6.000 L	1,2 m <sup>3</sup>	7200076739	3831116115374	2450 x 1350 x 2720	2 x TH6 x 4	6.240

Product	Volume	Max day inflow	Code	EAN	Dimension (mm)	Cover	Price (€)
2-5 PE EcoBox WEB	4.000 L	0,75 m <sup>3</sup>	7200079959	3831116128015	2330 x 1175 x 2440	2 x TH6 x 4	4.510
6-9 PE EcoBox WEB	6.000 L	1,2 m <sup>3</sup>	7200076739	3831116128022	2450 x 1350 x 2775	2 x TH6 x 4	6.770

Product	Volume	Max day inflow	Code	EAN	Dimension (mm)	Cover	Price (€)
2-5 PE EcoBox predpriprava	4.000 L	0,75 m <sup>3</sup>	7100076719	3831116153413	2330 x 1175 x 2440	2 x TH6 x 4	1.900
6-8 PE EcoBox predpriprava	6.000 L	1,2 m <sup>3</sup>	7100072299	3831116153420	2450 x 1350 x 2720	2 x TH6 x 4	2.940

Product	Code	EAN	Dimension (mm)	Price (€)
4 PE RoKit with installation (in Slovenia)	7210010009	3831116153437	-	2.830
8 PE RoKit with installation (in Slovenia)	7210010109	3831116153444	-	4.530





RoClean

WEB

Product	Volume	Max day inflow	Code	EAN	Dimension (mm)	Cover	Price (€)
4 PE RoClean	3.500 L	0,6 m <sup>3</sup>	7200079849	3831116107584	2080 x 1800 x 2050-2550	TH6 x 4	4.230
6 PE RoClean	5.000 L	0,9 m <sup>3</sup>	7200079859	3831116107591	2450 x 1800 x 2050-2550	TH6 x 4	4.940
8 PE RoClean	6.000 L	1,2 m <sup>3</sup>	7200079869	3831116107607	2820 x 1800 x 2050-2550	TH6 x 4	5.650
12 PE RoClean	8.000 L	1,8 m <sup>3</sup>	7200063779	3830010989050	2680 x 2300 x 2350-2850	2 x TH6 x 4	7.900
16 PE RoClean	10.000 L	2,4 m <sup>3</sup>	7200063789	3830010989067	3040 x 2300 x 2350-2850	2 x TH6 x 4	10.810
20 PE RoClean	12.000 L	3 m <sup>3</sup>	7200063799	3830050770090	3760 x 2300 x 2350-2850	2 x TH6 x 4	13.300
30 PE RoClean	16.000 L	5 m <sup>3</sup>	7200063769	3830010989043	4840 x 2300 x 2350-2850	3 x TH6 x 4	15.880
40 PE RoClean	16.000 L	6 m <sup>3</sup>	7200063829	3830010989074	4840 x 2300 x 2350-2850	1 x TH6 x 4 2xC8+H8	15.880
50 PE RoClean	20.000 L	8 m <sup>3</sup>	7200063839	3830050770083	4540 x 2420 x 2800-3100	1 x TH6 x 4 2xC8+H8	19.060

Product	Volume	Max day inflow	Code	EAN	Dimension (mm)	Cover	Price (€)
4 PE RoClean WEB	3.500 L	0,6 m <sup>3</sup>	7210079849	3831116162682	2080 x 1800 x 2050-2550	TH6 x 4	4.760
6 PE RoClean WEB	5.000 L	0,9 m <sup>3</sup>	7210079859	3831116162699	2450 x 1800 x 2050-2550	TH6 x 4	5.470
8 PE RoClean WEB	6.000 L	1,2 m <sup>3</sup>	7210079869	3831116162705	2820 x 1800 x 2050-2550	TH6 x 4	6.180
12 PE RoClean WEB	8.000 L	1,8 m <sup>3</sup>	7210063779	3831116127988	2680 x 2300 x 2350-2850	2 x TH6 x 4	8.430
16 PE RoClean WEB	10.000 L	2,4 m <sup>3</sup>	7210063789	3831116162712	3040 x 2300 x 2350-2850	2 x TH6 x 4	11.340
20 PE RoClean WEB	12.000 L	3 m <sup>3</sup>	7210063799	3831116127995	3760 x 2300 x 2350-2850	2 x TH6 x 4	13.830
30 PE RoClean WEB	16.000 L	5 m <sup>3</sup>	7210063769	3831116128008	4840 x 2300 x 2350-2850	3 x TH6 x 4	16.410
40 PE RoClean WEB	16.000 L	6 m <sup>3</sup>	7210063829	3831116125960	4840 x 2300 x 2350-2850	1 x TH6 x 4 2xC8+H8	16.410
50 PE RoClean WEB	20.000 L	8 m <sup>3</sup>	7210063839	3831116162729	4540 x 2420 x 2800-3100	1 x TH6 x 4 2xC8+H8	19.590

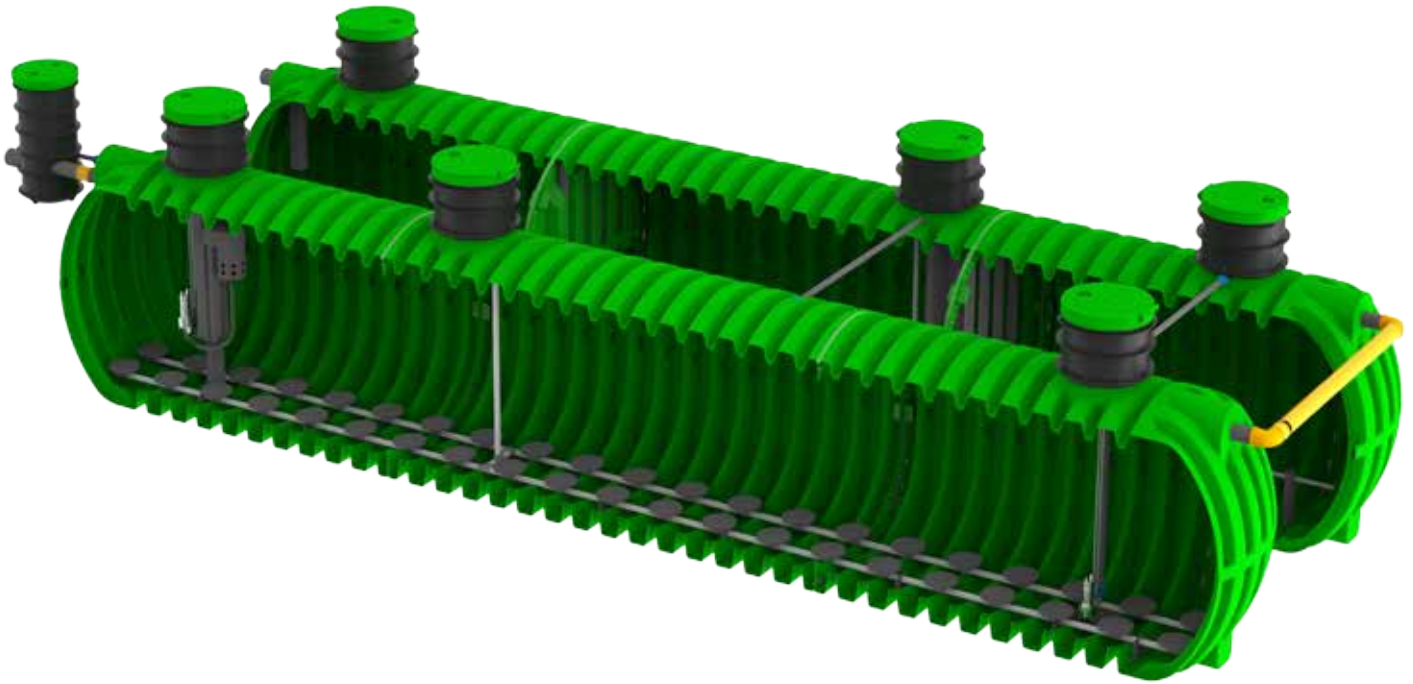

Product	Volume	Max day inflow	Code	EAN	Dimension (mm)	Cover	Price (€)
75 PE RoClean, SBR	25.000 L	12 m <sup>3</sup>	7200063859	3830050770113	5720 x 2420 x 2700-3000	3 x C8+H8	23.110
100 PE RoClean, SBR	30.000 L	15 m <sup>3</sup>	7200063849	3830050770106	6620 x 2450 x 2750-3100	3 x C8+H8	34.660
150 PE RoClean, SBR	40.000 L	23 m <sup>3</sup>	7200063869	3830050770120	8600 x 2450 x 2750-3100	3 x C8+H8	50.030
200 PE RoClean, SBR	50.000 L	30 m <sup>3</sup>	7200063879	3830050770137	10960 x 2450 x 2750-3100	3 x C8+H8	60.310
300 PE RoClean, SBR	65.000 L	45 m <sup>3</sup>	7200063889	3830050770144	13600 x 2450 x 2750-3100	4 x C8+H8	94.980

Product	Volume	Max day inflow	Code	EAN	Dimension (mm)	Cover	Price (€)
75 PE RoClean WEB	25.000 L	12 m <sup>3</sup>	7210063859	3831116162736	5720 x 2420 x 2700-3000	3 x C8+H8	23.700
100 PE RoClean WEB	30.000 L	15 m <sup>3</sup>	7210063849	3831116162743	6550 x 2425 x 2700-3000	3 x C8+H8	35.210
150 PE RoClean WEB	40.000 L	23 m <sup>3</sup>	7210063869	3831116162750	8510 x 2425 x 2700-3000	3 x C8+H8	50.600
200 PE RoClean WEB	50.000 L	30 m <sup>3</sup>	7210063879	3831116162767	10850 x 2425 x 2700-3000	3 x C8+H8	60.870
300 PE RoClean WEB	65.000 L	45 m <sup>3</sup>	7210063889	3831116162774	13460 x 2425 x 2700-3000	4 x C8+H8	95.390

Product	Volume	Max day inflow	Code	EAN	Dimension (mm)	Cover	Price (€)
100 PE RoGreen PRO	30.000 L	15 m <sup>3</sup>	7200063849	3831116125991	6550 x 2425 x 2700-3000	3 x C8+H8	40.070
150 PE RoGreen PRO	40.000 L	22,5 m <sup>3</sup>	7200063869	3831116126004	8510 x 2425 x 2700-3000	3 x C8+H8	57.980
200 PE RoGreen PRO	50.000 L	30 m <sup>3</sup>	7200063879	3831116126011	10850 x 2425 x 2700-3000	3 x C8+H8	73.030
300 PE RoGreen PRO	65.000 L	45 m <sup>3</sup>	7200063889	3831116126028	13460 x 2425 x 2700-3000	3 x C8+H8	107.740
400 PE RoGreen PRO	85.000 L	60 m <sup>3</sup>	7200063899	3831116126035	1x (9870 x 2425 x 2700-3000) 1x (8510 x 2425 x 2700-3000)	6 x C8+H8	120.310
500 PE RoGreen PRO	100.000 L	75 m <sup>3</sup>	7200063909	3831116126042	2x (10850 x 2425 x 2700-3000)	6 x C8+H8	135.790



Product	Material	Code	Dimension (mm)	Price (€)
Control cabinet P4	PE	7200088310	455 x 235 x 1350	160
Control cabinet P5	PE	7200088670	625 x 420 x 1400	200
Control cabinet P6 upper part	PE	7200088020	450 x 355 x 800	88
Control cabinet P6 cover	PE	7200088040	440 x 340 x 750	110
Control cabinet P6 lower part	PE	7200088030	470 x 420 x 830	140



Product	Material	Code	Dimension (mm)	Price (€)
Control cabinet B8	concrete	7102150940	1380 x 640 x 835	1.700
Control cabinet B13	concrete	7102150950	1380 x 640 x 1140	2.300



	Code	EM	Price (€)
Compressor AL 80	7111056	pcs	340
Compressor AL 120	7111049	pcs	620
Compressor AL 150	7111030	pcs	730
Compressor AL 250	7111036	pcs	1.330
Compressor AL 300	7111032	pcs	1.490
Blower for wwtp 2,2 KW (IVACO)	7111033	pcs	1.020













	Type WWTP	Code	EM	Price (€)
Control panel	RoEco 3-8 PE	0008840	pcs	300
Control panel	RoClean 2-50 PE, EcoBox 2-9PE	0008873	pcs	520
Adapter for wwtp Eco 6 with alarm		1280500	pcs	130
Adapter for wwtp Eco 6 - replacement		3733020	pcs	70
Control panel WEB				1.050



	Type WWTP	Code	EM	Price (€)
Pipe DN13x20	RoClean	1210204	m	4
Pipe DN19x26	RoEco	1210330	m	4
Electromagnetic valve	RoClean	3144170	pcs	190
Electromagnetic valve	RoEco	3144008	pcs	100
Plate difuzor	RoClean, EcoBox	1210297	pcs	40
Pipe difuzor	RoEco	0006910	pcs	32
Membrane for difuzor	RoEco	1255301	pcs	40



Waste water treatment plants		FINE SCREEN BAR	Mechanical removal of non - degradable particles in wastewater	Vertical fine screen Control unit for fine screen bar	For assembling in pumping station, depth 4000 mm	17.500 6.200
		PUMPING STATION	Pumping fecal water to a higher level	PE or GRP		per project
Water tanks		CHEMICAL FILTER	Removal of unpleasant odors from WWTP	Chemical filter from 20m <sup>3</sup> /h Chemical filter till 400m <sup>3</sup> /h		page 13
		DECANTER	Leakage of purified water from the reactor	PE or INOX		per project
Oil separators		UV DEZINFECTION	Tertiary water treatment when purified water goes and bathing water or reused			per project
		DOSING SYSTEM	The set contains a dosing pump and a PE tank up to 100 L	Flocculant dosing system Base dosing system Acid dosing system	7900520730	2.160 4.320 5.720
Grease separators		SUBMERSIBLE VERTICAL MIXER	Denitrification		7900520740	per project
		OXYGEN SENSOR	Measurement and regulation of molten oxygen in the wastewater and the reactor	Sensor for oxygen (T) Sensor for oxygen (T) with control unit and controler Sensor for oxygen (T) with control unit	7900520770 7900520800 7900520750	8.270 9.160 4.960
Pumping stations		CONTINUOUS LEVEL GAUGE	Measurement of wastewater level in the tank and reactor	Continuous level gauge with control unit	7900520760	2.190
		FLOW METER	Flow measurement at the treatment plant	Flow meter up to DN50	7900520780	8.520
Shafts		CONTAINER - SERVICE BUILDING	Software for remote monitoring, control and archiving of data and WWTPs	Different dimensions		per project
		SCADA	Built-in hardware and electrical equipment of the treatment plant			per project



Product	Code	EAN	Max. flow	Dim. (mm)	Filler amount (kg)	Price (€)
Chemical filter 10 NV (with natural traction)	7900520810	3831116162798	10	250 x 520	5	2.359
Chemical filter 20 NV (with natural traction)	7900520820	3831116162804	20	250 x 800	11	2.644
Chemical filter 30 NV (with natural traction)	7900520830	3831116162811	30	250 x 900	15	3.001
Chemical filter 40 NV (with natural traction)	7900520840	3831116162828	40	400 x 700	20	3.467
Chemical filter 50 NV (with natural traction)	7900520850	3831116162835	50	400 x 800	25	3.773
Chemical filter 60 NV (with natural traction)	7900520860	3831116162842	60	400 x 900	30	4.566

Product	Code	EAN	Max. flow	Dim. (mm)	Filler amount (kg)	Price (€)
Chemical filter 20 with fan, without electrical cabinet	7900520870	3831116162859	20	250 x 800	10	4.155
Chemical filter 50 with fan, without electrical cabinet	7900520880	3831116162866	50	400 x 850	25	4.974
Chemical filter 100 with fan, without electrical cabinet	7900520890	3831116162873	100	600 x 800	50	9.601
Chemical filter 400 with fan, without electrical cabinet	7900520900	3831116162880	400	800 x 1300	200	14.562

Product	Code	EAN	Max. flow	Dim. (mm)	Filler amount (kg)	Price (€)
Chemical filter 20 with fan, with electric cabinet	7900520910	3831116162897	20	250 x 800	10	8.163
Chemical filter 50 with fan, with electric cabinet	7900520920	3831116162903	50	400 x 850	25	8.873
Chemical filter 100 with fan, with electric cabinet	7900520930	3831116162910	100	600 x 800	50	14.631
Chemical filter 400 with fan, with electric cabinet	7900520940	3831116162927	400	800 x 1300	200	26.880

Services in Slovenia	Code	EM	VPC (€)
Inspection and adjustment of the treatment plant	9151060	pcs	65
SERVICE mini	9151031	pcs	230
SERVICE maxi	9151030	pcs	340
START UP WWTP	9151032	pcs	160

Services in Slovenia	Code	EM	VPC (€)
SERVICER - hour	9151090	hour	40
SERVICER welder - hour	9151095	hour	50
ENGINEER - hours		hour	60
Travel cost from servicer	9151036	km	0,43
Travel time for servicer	9151040	hour	33
The cost of a worker's overnight stay in the field		night/person	160

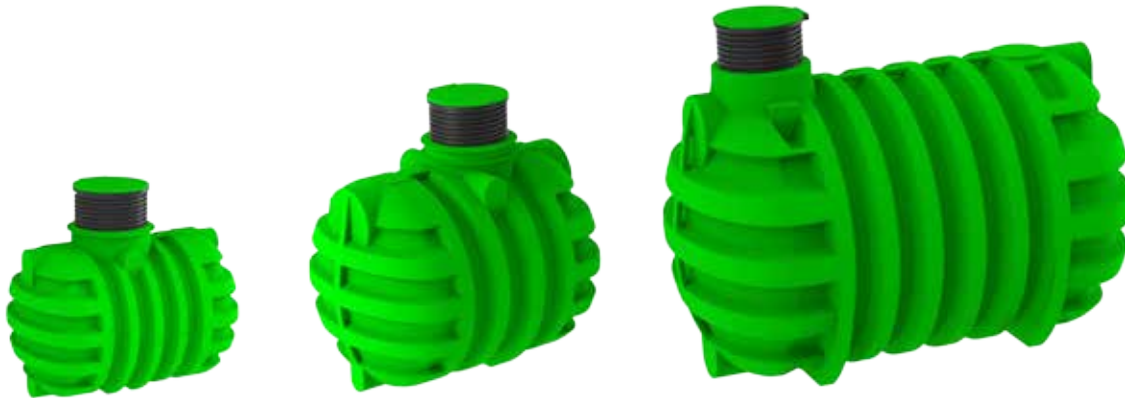

Product	Code	EAN	Dim. (mm)	Cover	Price (€)
2.200 L RoTerra Water	7100067169	3831116113295	1840 x 1400 x 1600 - 1900	TH6 x 4	980
2.600 L RoTerra Water	7100067189	3831116110065	2150 x 1400 x 1600 - 1900	TH6 x 4	1.050
3.000 L RoTerra Water	7100067179	3831116113288	2400 x 1400 x 1600 - 1900	TH6 x 4	1.110
3.300 L RoTerra Water	7100069489	3831116125212	2650 x 1400 x 1600 - 1900	TH6 x 4	1.220

Product	Code	EAN	Dim. (mm)	Cover	Price (€)
3.500 L RoTerra Water	7100067129	3831116107546	2080 x 1800 x 2050 - 2350	TH6 x 4	1.280
5.000 L RoTerra Water	7100067139	3831116107553	2450 x 1800 x 2050 - 2350	TH6 x 4	1.430
6.000 L RoTerra Water	7100067149	3831116107560	2820 x 1800 x 2050 - 2350	TH6 x 4	1.800

Product	Code	EAN	Dim. (mm)	Cover	Price (€)
8.000 L RoTerra	7100062549	3830010987063	2680 x 2300 x 2500-2880	TH6 x 4	2.430
10.000 L RoTerra	7100069039	3831116117682	3040 x 2300 x 2500-2880	TH6 x 4	2.650
12.000 L RoTerra	7100062509	3830010981849	3760 x 2300 x 2500-2880	TH6 x 4	3.020
16.000 L RoTerra	7100065779	3830010989784	4840 x 2300 x 2500-2880	TH6 x 4	3.710

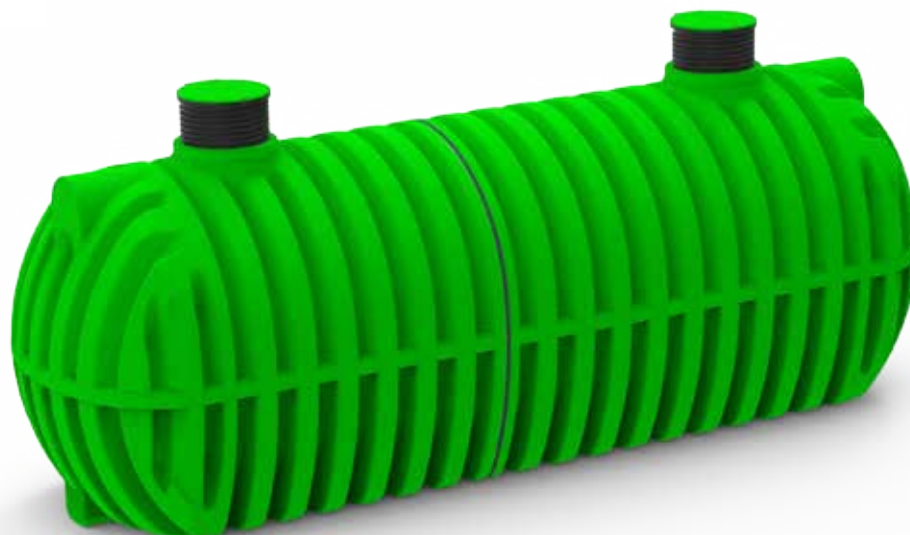

Product	Code	EAN	Dim. (mm)	Cover	Price (€)
20.000 L RoTerra 2450	7100062679	3831116152423	4540 x 2420 x 2700-3100	TH6 x 4	4.770
25.000 L RoTerra 2450	7100062689	3831116152447	5720 x 2420 x 2700-3000	TH6 x 4	6.050
30.000 L RoTerra 2450	7110030009	3831116141359	6550 x 2425 x 2700-3000	2 x TH6 x 4	8.160
35.000 L RoTerra 2450	7110035009	3831116141366	7530 x 2425 x 2700-3000	2 x TH6 x 4	8.850
40.000 L RoTerra 2450	7110040009	3831116141373	8510 x 2425 x 2700-3000	2 x TH6 x 4	9.750
45.000 L RoTerra 2450	7110045009	3831116141380	9870 x 2425 x 2700-3000	3 x TH6 x 4	12.190
50.000 L RoTerra 2450	7110050009	3831116141397	10850 x 2425 x 2700-3000	3 x TH6 x 4	13.250
55.000 L RoTerra 2450	7110055009	3831116141403	11500 x 2425 x 2700-3000	3 x TH6 x 4	13.780
60.000 L RoTerra 2450	7110060009	3831116141410	12480 x 2425 x 2700-3000	3 x TH6 x 4	15.050
65.000 L RoTerra 2450	7110065009	3831116141427	13600 x 2425 x 2700-3000	3 x TH6 x 4	16.430





**RoBox**



**RoBox**



**RotoM**



**RoCko**

Product	Code	EAN	Dim. (mm)	Cover	Price (€)
4.000 L RoBox	7100076719	3830050775255	2320 x 1150 x 1930	2 x TH6 x 4	1.690
6.000 L RoBox	7100079969	3831116115503	2450 x 1350 x 2720	2 x TH6 x 4	2.720

Product	Code	EAN	Dim. (mm)	Cover	Price (€)
5.000 L RoBox	7100072299	3831116146552	2690 x 1890 x 1200	1 x TH6 x 4	1.660

Product	Code	EAN	Dim. (mm)	Cover	Price (€)
2.300 L RotoM vertical	7100067209	3830050779642	2180 x 700 x 1725	1 x T4	820
2.100 L RotoM horizontal	7100067219	3830050779659	2180 x 1725 x 700	1 x T4	980

Product	Code	EAN	Dim. (mm)	Cover	Price (€)
3.500 L RoCko freestanding	7100067039	3830050771165	Ø2310 x 1300-2000	1 x C8+H8	1.600
5.000 L RoCko freestanding	7100067079	3830050774661	Ø2310 x 1650-2350	1 x C8+H8	1.810

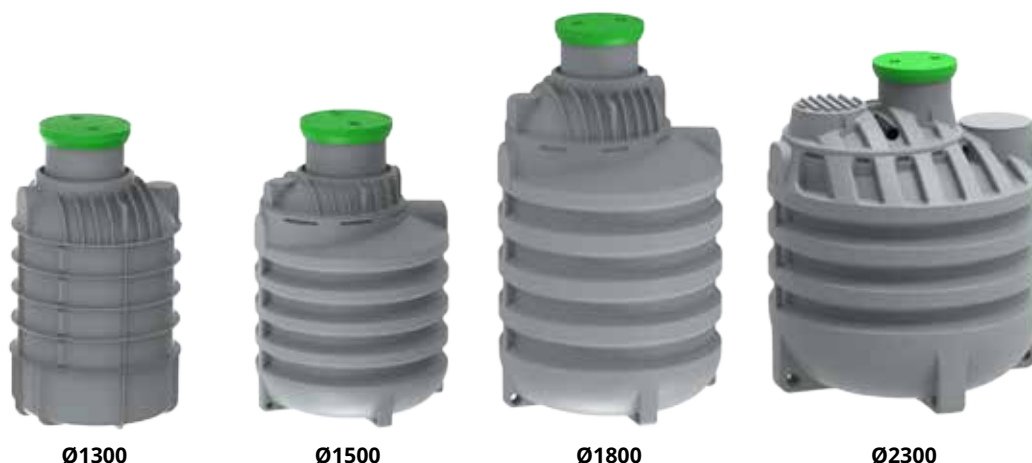

Ø1300

Ø1500

Ø1800

Ø2300

Product	Code	EAN	Dim. (mm)	Cover	Price (€)
900 L RoCko	7100057619	3831116118665	Ø1300 x 1300	H6	590
1.200 L RoCko	7100057629	3831116118672	Ø1300 x 1550	H6	640
1.500 L RoCko	7100057639	3831116118689	Ø1300 x 1800	H6	700
1.700 L RoCko	7100057819	3830050772681	Ø1300 x 2050	H6	730
2.000 L RoCko	7100057649	3831116118696	Ø1300 x 2300	H6	800
2.300 L RoCko	7100057659	3831116118702	Ø1300 x 2550	H6	970
2.500 L RoCko	7100057849	3830050772711	Ø1300 x 2800	H6	1.000
2.800 L RoCko	7100057669	3831116118719	Ø1300 x 3050	H6	1.280

Product	Code	EAN	Dim. (mm)	Cover	Price (€)
2.000 L RoCko	7100067459	3831116115466	Ø1500 x 2000	H6	730
2.350 L RoCko	7100067469	3831116115473	Ø1500 x 2250	H6	970
2.700 L RoCko	7100067479	3831116115480	Ø1500 x 2500	H6	1.280

Product	Code	EAN	Dim. (mm)	Cover	Price (€)
3.200 L RoCko	7100067269	3831116115152	Ø1800 x 2350	H6	1.300
4.000 L RoCko	7100067279	3831116115169	Ø1800 x 2700	H6	1.450

Product	Code	EAN	Dim. (mm)	Cover	Price (€)
6.000 L RoCko	7100067349	3831116116470	Ø2300 x 2400	H6	2.000
7.500 L RoCko	7100067359	3831116116487	Ø2300 x 2750	H6	2.160
8.700 L RoCko	7100067369	3831116116494	Ø2300 x 3100	H6	2.320
10.000 L RoCko	7100067379	3831116116500	Ø2300 x 3500	H6	2.480



**Roto**



**RoTerra**



**RoVoda**



**RoOki**

Product	Code	EAN	Dim. (mm)	Cover	Price (€)
500 L Roto	7100062259	3830010981863	1130 x 860 x 890	T4	270
1.000 L Roto	7100062389	3830010985816	1580 x 1060 x 1080	T4	560

Product	Code	EAN	Dim. (mm)	Cover	Price (€)
3.500 L RoTerra	7100062729	3830010989333	1987 x 1800 x 2050-2550	TH6 x 4	1.280
5.000 L RoTerra	7100062739	3830010981313	2450 x 1800 x 2050-2550	TH6 x 4	1.430
6.000 L RoTerra	7100062749	3830010981429	2820 x 1800 x 2050-2550	TH6 x 4	1.800

Product	Code	EAN	Dim. (mm)	Cover	Price (€)
3.500 L RoVoda	7100090409	3831116117361	1983 x 1800 x 2230	H6	1.280
5.000 L RoVoda	7100090419	3831116117378	2480 x 1800 x 2230	H6	1.430
6.000 L RoVoda	7100090429	3831116117385	2880 x 1800 x 2230	H6	1.800

Product	Code	EAN	Dim. (mm)	Cover	Price (€)
3.000 L RoOki	7100527709	3831116123669	2350 x 1340 x 1670	S6	1.050
5.000 L RoOki	7100527719	3831116123676	2400 x 1800 x 2160	S6	1.380
10.000 L RoOki	7100527729	3831116123683	3250 x 2200 x 2360	S6	2.410

Waste water treatment plants

Water tanks

Oil separators

Grease separators

Pumping stations

Shafts



RoNdo



RoTrans

Product	Code	EAN	Dim. (mm)	Cover	Price (€)
500 L RoNdo	7100527319	3831116123461	Ø740 x 1350	T4	200
800 L RoNdo	7100527329	3831116123478	Ø840 x 1600	T4	340
1.000 L RoNdo	7100527339	3831116123485	Ø950 x 1650	T4	460
1.500 L RoNdo	7100527349	3831116123492	Ø1100 x 1850	T4	540
2.000 L RoNdo	7100527359	3831116123508	Ø1200 x 1950	T4	630
3.000 L RoNdo	7100527409	3831116123515	Ø1860 x 1370	T4	710
4.000 L RoNdo	7100527419	3831116123522	Ø1860 x 1790	T4	800
5.000 L RoNdo	7100062499	3830010982495	Ø1800 x 2200	T4	1.110
6.000 L RoNdo	7100527429	3831116123539	Ø1860 x 2510	T4	1.260
8.000 L RoNdo	7100527439	3831116123546	Ø2460 x 2020	T6	1.510
10.000 L RoNdo	7100527449	3831116123553	Ø2460 x 2470	T6	1.750
15.000 L RoNdo	7100527459	3831116123560	Ø2460 x 3620	T6	3.570

Product	Code	EAN	Dim. (mm)	Cover	Price (€)
300 L RoTrans	7100527209	3831116123386	1220 x 590 x 660	T4	130
500 L RoTrans	7100527219	3831116123393	1440 x 680 x 820	T4	170
1.000 L RoTrans	7100527229	3831116123409	1720 x 860 x 990	T4	230
1.500 L RoTrans	7100527239	3831116123416	1610 x 1180 x 1310	T4	420
2.000 L RoTrans	7100527249	3831116123423	1720 x 1250 x 1400	T4	630
3.000 L RoTrans	7100527259	3831116123430	2030 x 1430 x 1600	T4	710
5.000 L RoTrans	7100527269	3831116123447	2150 x 1800 x 1960	T4	1.030



**RoQuadro**



**RoDrink**

Product	Code	EAN	Dim. (mm)	Cover	Price (€)
250 L RoQuadro	7104103269	3858883818710	600 x 600 x 910	T4	190
500 L RoQuadro	7104104069	3858883816143	760 x 760 x 1100	T4	270
750 L RoQuadro	7104106069	3858883812756	760 x 760 x 1600	T4	380
1.000 L RoQuadro	7104107669	3858883818413	1520 x 760 x 1100	2 x T4	510
1.500 L RoQuadro	7100065459	3830010985458	1450 x 750 x 1700	2 x T4	590
2.000 L RoQuadro	7104109469	3858883817881	2250 x 760 x 1600	2 x T4	980

Product	Code	EAN	Dim. (mm)	Cover	Price (€)
2.200 L RoDrink	7100067169	3831116126615	1840 x 1400 x 1600-1900	TH6 x 4	1.240
3.000 L RoDrink	7100067179	3831116126639	2400 x 1400 x 1600-1900	TH6 x 4	1.450
5.000 L RoDrink	7100090419	3831116126653	2450 x 1800 x 2050-2350	TH6 x 4	1.790
6.000 L RoDrink	7100090429	3831116107560	2820 x 1800 x 2050-2350	TH6 x 4	2.340
8.000 L RoDrink	7100062549	3830010987063	2680 x 2300 x 2500-2880	TH6 x 4	3.180
10.000 L RoDrink	7100069039	3831116117132	3040 x 2300 x 2500-2880	TH6 x 4	3.450
12.000 L RoDrink	7100062509	3831116126684	3760 x 2300 x 2500-2880	TH6 x 4	3.920
16.000 L RoDrink	7100065779	3831116126691	4840 x 2300 x 2500-2880	TH6 x 4	4.820
20.000 L RoDrink	7100062679	3831116152447	4690 x 2425 x 2620-3000	2 x TH6 x 4	6.250
25.000 L RoDrink	7100062709	3831116152454	5720 x 2425 x 2620-3000	2 x TH6 x 4	6.890

30.000 L RoDrink	7100062359	3830043917181	6550 x 2425 x 2620-3000	2 x C8 + H8	11.340
35.000 L RoDrink	7100862379	3831116117149	7530 x 2425 x 2620-3000	2 x C8 + H8	12.400
40.000 L RoDrink	7100062379	3830043917198	8510 x 2425 x 2620-3000	2 x C8 + H8	13.670
45.000 L RoDrink	7100862429	3831116117156	9870 x 2425 x 2620-3000	3 x C8 + H8	17.070
50.000 L RoDrink	7100062429	3830043917204	10850 x 2425 x 2620-3000	3 x C8 + H8	18.550
55.000 L RoDrink	7100055009	3831116153451	11500 x 2425 x 2620-3000	3 x C8 + H8	19.290
60.000 L RoDrink	7100060009	3831116153468	12480 x 2425 x 2620-3000	3 x C8 + H8	21.090
65.000 L RoDrink	7100065009	3831116153475	13460 x 2425 x 2620-3050	3 x C8 + H8	23.000



Product	Code	EAN	Dim. (mm)	Price (€)
GARDEN KIT DAB (Pump in the tank)	7100062660	3830010988114	-	650
HOUSE KIT GRUNDFOS (Pump in the tank)	7100091370	3830050770915	-	1.400



Product	Code	EAN	Dim. (mm)	Price (€)
FILTER SET DN 110	7100062480	3830010987223	-	490
FILTER SET DN160	7100062470		-	660
filter- sit	7181530010	3830010986202	Ø400 x 200	70
filter for saniter water	7100065490	3830010989562	-	410
filter with UV dezinfection	7100092810	3830027565834	-	1.430



Product	Code	EAN	Dim. (mm)	Price (€)
gutter shaft L	7100070950	3830010989593	Ø250 x 600	50
gutter shaft I	7100520080	3831116126974	Ø250 x 450 x 550	50



Product	Code	EAN	Dim. (mm)	Price (€)
water meter level - basic	7100065560	3830010989586	Apolo	160
water meter level - profi	7100063220	3831116113585	Navis	370



Product	Code	EAN	Dim. (mm)	Price (€)
sandshaft with filter Ø400 x 800 and cover	7100065970	3830050771431	Ø400 x 800	270
sandshaft with filter Ø600 x 800 and cover	7100065920	3830010989548	Ø600 x 800	360



Product	Code	EAN	Dim. (mm)	Price (€)
fine filter Ø400 x 430 (400 m <sup>2</sup> roof surface)	7100092800	4018712000085	Ø400 x 450	370
fine filter duo (1000 m <sup>2</sup> roof surface)	7100066180	3831116128039	470 x 680 x 870	1.110
extension for fine filter Ø400	7100092820	3831116131220		170



Product	Code	EAN	Price (€)
Parallel connection of PE 100 DN 150 tanks (flange connection)	7100291400	3831116152614	1.090
Parallel connection of PE 100 DN 200 tanks (flange connection)	7100291410	3831116152621	1.770
Serial connection of PE 100 DN 150 tanks (flange connection)	7100291420	3831116152638	760
Serial connection of PE 100 DN 200 tanks (flange connection)	7100291430	3831116152645	1.070
Vent PE DN 100	7100291440	3831116152652	280
Inox vent DN 100	7100291450	3831116152669	820
Suction pipe inox DN125 typ A	7100291460	3831116152676	1.390
Type A non-return valve suction basket (110 mm)	7100070570	3831116159972	1.003
Tank access leder inox	7100291470	3831116152683	1.380



**RoSep I. class**



**RoSep II. class**

Product	Volume	Surface	Code	EAN	Dim. (mm)	Cover	Price (€)
NS 3 SIP RoSep	2.200 L	120 m <sup>2</sup>	7300075959	3830010987964	1840 x 1400 x 1600-1900	1 x TH6 x 4	2.120
NS 6 SIP RoSep	3.000 L	240 m <sup>2</sup>	7300075979	3830010987971	2400 x 1400 x 1600-1900	1 x TH6 x 4	2.510
NS 10 SIP RoSep	3.500 L	400 m <sup>2</sup>	7300072759	3830050772858	2080 x 1800 x 2050-2350	1 x TH6 x 4	3.030
NS 15 SIP RoSep	5.000 L	600 m <sup>2</sup>	7300075999	3830010987988	2450 x 1800 x 2050-2350	1 x TH6 x 4	3.490
NS 20 SIP RoSep	6.000 L	800 m <sup>2</sup>	7300075889	3830010987995	2820 x 1800 x 2050-2350	1 x TH6 x 4	4.760
NS 30 SIP RoSep	8.000 L	1.200 m <sup>2</sup>	7300072739	3830010987087	2680 x 2300 x 2500-2880	1 x TH6 x 4+C8+H8	5.410
NS 40 SIP RoSep	10.000 L	1.600 m <sup>2</sup>	7300072789	3830010987084	3040 x 2300 x 2500-2880	1 x TH6 x 4+C8+H8	6.240
NS 50 SIP RoSep	12.000 L	2.000 m <sup>2</sup>	7300072769	3830010988145	3760 x 2300 x 2500-2880	1 x TH6 x 4+C8+H8	6.890
NS 65 SIP RoSep	16.000 L	2.600 m <sup>2</sup>	7300072009	3830010988145	4840 x 2300 x 2500-2880	1 x TH6 x 4+C8+H8	8.570
NS 80 SIP RoSep	20.000 L	3.200 m <sup>2</sup>	7300072899	3830050776153	4540 x 2420 x 2800-3100	2 x C8+H8	10.020
NS 100 SIP RoSep	25.000 L	4.000 m <sup>2</sup>	7300074219	3830050775798	5720 x 2420 x 2700-3000	2 x C8+H8	10.390
NS 125 SIP RoSep	30.000 L	5.080 m <sup>2</sup>	7300072019	3831116115527	6550 x 2425 x 2700-3000	2 x C8+H8+C10+H10	11.800
NS 150 SIP RoSep	35.000 L	6.100 m <sup>2</sup>	7300075929	3830050776160	7530 x 2425 x 2700-3000	2 x C8+H8+C10+H10	13.670
NS 200 SIP RoSep	40.000 L	8.100 m <sup>2</sup>	7300075989	3831116114858	8510 x 2425 x 2700-3000	2 x C8+H8+C10+H10	15.140
NS 250 SIP RoSep	45.000 L	10.100 m <sup>2</sup>	7300076009	3831116114612	9870 x 2425 x 2700-3000	2 x C8+H8+C10+H10	17.590
NS 300 SIP RoSep	50.000 L	12.100 m <sup>2</sup>	7300072029	3831116115534	10850 x 2425 x 2700-3000	2 x C8+H8+C10+H10	21.200

Product	Volume	Surface	Code	EAN	Dim. (mm)	Cover	Price (€)
NS 3 SIIP RoSep	2.200 L	120 m <sup>2</sup>	7300075909	3830010988176	1840 x 1400 x 1600-1900	1 x TH6 x 4	1.290
NS 6 SIIP RoSep	3.000 L	240 m <sup>2</sup>	7300075919	3830010988183	2400 x 1400 x 1600-1900	1 x TH6 x 4	1.450
NS 10 SIIP RoSep	3.500 L	400 m <sup>2</sup>	7300072889	3830050775316	2080 x 1800 x 2050-2350	1 x TH6 x 4	1.750
NS 15 SIIP RoSep	5.000 L	600 m <sup>2</sup>	7300075939	3830010986486	2450 x 1800 x 2050-2350	1 x TH6 x 4	1.860
NS 20 SIIP RoSep	6.000 L	800 m <sup>2</sup>	7300072719	3830010988190	2820 x 1800 x 2050-2350	1 x TH6 x 4	2.280
NS 30 SIIP RoSep	8.000 L	1.200 m <sup>2</sup>	7300072729	3830010988299	2680 x 2300 x 2500-2880	1 x TH6 x 4+S4	3.360
NS 40 SIIP RoSep	10.000 L	1.600 m <sup>2</sup>	7300072749	3830010988343	3040 x 2300 x 2500-2880	1 x TH6 x 4+S4	3.580
NS 50 SIIP RoSep	12.000 L	2.000 m <sup>2</sup>	7300072779	3830010988404	3760 x 2300 x 2500-2880	1 x TH6 x 4+S4	3.950
NS 65 SIIP RoSep	16.000 L	2.600 m <sup>2</sup>	7300072059	3830010988404	4840 x 2300 x 2500-2880	1 x TH6 x 4+S4	4.640
NS 80 SIIP RoSep	20.000 L	3.200 m <sup>2</sup>	7300072949	3830050774500	4540 x 2420 x 2800-3100	2 x TH6 x 4	5.940
NS 100 SIIP RoSep	25.000 L	4.000 m <sup>2</sup>	7300074229	3830050775309	5720 x 2420 x 2700-3000	2 x TH6 x 4	7.000



Product - classic	Code	EAN	Dimensions (mm)	Cover	Price (€)
NS 10 v 5.000 L typ A <a href="#">RoPetrol</a>	7330001019	3831116133040	2450 x 1800 x 2050-2350	1 x TH6 x 4+S4	6.200
NS 15 v 5.000 L typ A <a href="#">RoPetrol</a>	7330001519	3831116133088	2450 x 1800 x 2050-2350	1 x TH6 x 4+S4	6.200
NS 20 v 6.000 L typ A <a href="#">RoPetrol</a>	7330002019	3831116133125	2820 x 1800 x 2050-2350	1 x TH6 x 4+S4	7.770
NS 30 v 8.000 L typ A <a href="#">RoPetrol</a>	7330003019	3831116133163	2680 x 2300 x 2500-2880	2 x TH6 x 4	8.720
NS 40 v 10.000 L typ A <a href="#">RoPetrol</a>	7330004019	3831116133200	3040 x 2300 x 2500-2880	2 x TH6 x 4	9.560

Product - classic	Code	EAN	Dimensions (mm)	Cover	Price (€)
NS 10 v 5.000 L typ B <a href="#">RoPetrol</a>	7330001029	3831116133064	2450 x 1800 x 2050-2350	1 x TH6 x 4+S4	6.200
NS 15 v 6.000 L typ B <a href="#">RoPetrol</a>	7330001529	3831116133101	2820 x 1800 x 2050-2350	1 x TH6 x 4+S4	7.770
NS 20 v 8.000 L typ B <a href="#">RoPetrol</a>	7330002029	3831116133149	2680 x 2300 x 2500-2880	2 x TH6 x 4	8.720
NS 30 v 12.000 L typ B <a href="#">RoPetrol</a>	7330003029	3831116133187	3760 x 2300 x 2500-2880	2 x TH6 x 4	9.560
NS 40 v 16.000 L typ B <a href="#">RoPetrol</a>	7330004029	3831116133224	4840 x 2300 x 2500-2880	2 x TH6 x 4	10.870

Product - conductive	Code	EAN	Dimensions (mm)	Cover	Price (€)
NS 10 v 5.000 L typ A <a href="#">RoPetrol</a>	7330001019	3831116133057	2450 x 1800 x 2050-2350	1 x TH6 x 4+S4	6.950
NS 15 v 5.000 L typ A <a href="#">RoPetrol</a>	7330001519	3831116133095	2450 x 1800 x 2050-2350	1 x TH6 x 4+S4	6.950
NS 20 v 6.000 L typ A <a href="#">RoPetrol</a>	7330002019	3831116133132	2820 x 1800 x 2050-2350	1 x TH6 x 4+S4	8.530
NS 30 v 8.000 L typ A <a href="#">RoPetrol</a>	7330003019	3831116133170	2680 x 2300 x 2500-2880	2 x TH6 x 4	9.430
NS 40 v 10.000 L typ A <a href="#">RoPetrol</a>	7330004019	3831116133217	3040 x 2300 x 2500-2880	2 x TH6 x 4	10.490

Product - conductive	Code	EAN	Dimensions (mm)	Cover	Price (€)
NS 10 v 5.000 L typ B <a href="#">RoPetrol</a>	7330001029	3831116133071	2450 x 1800 x 2050-2350	1 x TH6 x 4+S4	6.950
NS 15 v 6.000 L typ B <a href="#">RoPetrol</a>	7330001529	3831116133118	2820 x 1800 x 2050-2350	1 x TH6 x 4+S4	8.530
NS 20 v 8.000 L typ B <a href="#">RoPetrol</a>	7330002029	3831116133156	2680 x 2300 x 2500-2880	2 x TH6 x 4	9.430
NS 30 v 12.000 L typ B <a href="#">RoPetrol</a>	7330003029	3831116133194	3760 x 2300 x 2500-2880	2 x TH6 x 4	10.490
NS 40 v 16.000 L typ B <a href="#">RoPetrol</a>	7330004029	3831116133231	4840 x 2300 x 2500-2880	2 x TH6 x 4	11.980

Oil separator for gas station have a 2x larger settling tank than in car parks. They are made of a special material that is antistatic and has ATEX certification 48-061-041 / 11.

Oil separator typ A have settler with volume NS×100  
Oil separator typ B have settler with volume NS×200

The price includes:

- LTŽ COVER with description separator
- Automatic cloasur on inflow with floters and measure scale
- Shamplng shaft
- Lamellar coalescent filter





**RoSep 10% bypass**



**RoSep 20% bypass**

Product	Volume	Surface	Code	EAN	Dim. (mm)	Cover	Price (€)
NS 30/3 BP RoSep	2.200 L	1.200 m <sup>2</sup>	7300068909	3830050773145	1840 x 1400 x 1600-1900	1 x TH6 x 4	2.860
NS 50/5 BP RoSep	2.600 L	2.400 m <sup>2</sup>	7300068919	3830050774159	2150 x 1400 x 1600-1900	1 x TH6 x 4	3.180
NS 80/8 BP RoSep	3.000 L	3.200 m <sup>2</sup>	7300068989	3830050772230	2400 x 1400 x 1600-1900	1 x TH6 x 4	3.470
NS 100/10 BP RoSep	3.500 L	4.000 m <sup>2</sup>	7300068929	3830050776726	2080 x 1800 x 2050-2350	1 x TH6 x 4	4.230
NS 150/15 BP RoSep	5.000 L	6.100 m <sup>2</sup>	7300068939	3830050771400	2450 x 1800 x 2050-2350	1 x TH6 x 4	4.550
NS 200/20 BP RoSep	6.000 L	8.100 m <sup>2</sup>	7300068949	3830050772315	2820 x 1800 x 2050-2350	1 x TH6 x 4	5.710
NS 250/25 BP RoSep	8.000 L	10.100 m <sup>2</sup>	7300068619	3831116115671	2680 x 2300 x 2500-2880	1 x TH6 x 4+C8+H8	6.360
NS 300/30 BP RoSep	10.000 L	12.100 m <sup>2</sup>	7300068959	3830050772384	3040 x 2300 x 2500-2880	1 x TH6 x 4+C8+H8	6.890
NS 400/40 BP RoSep	12.000 L	16.200 m <sup>2</sup>	7300068969	3830050772483	3760 x 2300 x 2500-2880	1 x TH6 x 4+C8+H8	8.160
NS 500/50 BP RoSep	16.000 L	20.300 m <sup>2</sup>	7300068979	3831116113899	4840 x 2300 x 2500-2880	1 x TH6 x 4+C8+H8	9.120
NS 650/65 BP RoSep	20.000 L	25.400 m <sup>2</sup>	7300068569	3831116115626	4540 x 2420 x 2800-3100	2 x C8+H8	9.650
NS 800/80 BP RoSep	25.000 L	28.500 m <sup>2</sup>	7300068579	3831116115633	5720 x 2420 x 2700-3000	2 x C8+H8	12.190
NS 1000/100 BP RoSep	30.000 L	40.600 m <sup>2</sup>	7300068589	3831116115640	6550 x 2425 x 2700-3000	2 x C8+H8	13.780
NS 1250/125 BP RoSep	35.000 L	50.800 m <sup>2</sup>	7300068599	3831116115657	7530 x 2425 x 2700-3000	2 x C8+H8; C10+H10	15.370
NS 1500/150 BP RoSep	40.000 L	61.000 m <sup>2</sup>	7300068609	3831116115664	8510 x 2425 x 2700-3000	2 x C8+H8; C10+H10	19.080
NS 2000/200 BP RoSep	45.000 L	81.300 m <sup>2</sup>	7300068809	3830050771998	9870 x 2425 x 2700-3000	2 x C8+H8; C10+H10	20.460
NS 2500/250 BP RoSep	50.000 L	101.600 m <sup>2</sup>	7300068639		10850 x 2425 x 2700-3000	2 x C8+H8; C10+H10	22.790

Product	Volume	Surface	Code	EAN	Dim. (mm)	Cover	Price (€)
NS 15/3 BP RoSep	2.200 L	600 m <sup>2</sup>	7300068809	3830050771998	1840 x 1400 x 1600-1900	1 x TH6 x 4	3.620
NS 30/6 BP RoSep	3.000 L	1.200 m <sup>2</sup>	7300068819	3830050773220	2400 x 1400 x 1600-1900	1 x TH6 x 4	3.920
NS 50/10 BP RoSep	3.500 L	2.000 m <sup>2</sup>	7300068509	3830050773237	2080 x 1800 x 2050-2350	1 x TH6 x 4	4.180
NS 80/16 BP RoSep	5.000 L	3.000 m <sup>2</sup>	7300068829	3830050772292	2450 x 1800 x 2050-2350	1 x TH6 x 4	5.000
NS 100/20 BP RoSep	6.000 L	4.000 m <sup>2</sup>	7300068849	3830050776184	2820 x 1800 x 2050-2350	1 x TH6 x 4	5.510
NS 150/30 BP RoSep	8.000 L	6.100 m <sup>2</sup>	7300068859	3830050771394	2680 x 2300 x 2500-2880	1 x TH6 x 4; C8+H8	6.550
NS 200/40 BP RoSep	10.000 L	8.100 m <sup>2</sup>	7300068869	3830050772308	3040 x 2300 x 2500-2880	1 x TH6 x 4; C8+H8	6.930
NS 250/50 BP RoSep	12.000 L	10.100 m <sup>2</sup>	7300068879	3830050778485	3760 x 2300 x 2500-2880	1 x TH6 x 4; C8+H8	7.950
NS 325/65 BP RoSep	16.000 L	13.200 m <sup>2</sup>	7300068839	3830050772292	4840 x 2300 x 2500-2880	1 x TH6 x 4; C8+H8	10.070
NS 400/80 BP RoSep	20.000 L	16.200 m <sup>2</sup>	7300068889	3830050772476	4540 x 2420 x 2800-3100	2 x C8+H8	10.720
NS 500/100 BP RoSep	25.000 L	20.300 m <sup>2</sup>	7300068899	3830050779932	5720 x 2420 x 2700-3000	2 x C8+H8	12.410
NS 625/125 BP RoSep	30.000 L	25.400 m <sup>2</sup>	7300068519	3831116115572	6550 x 2425 x 2700-3000	2 x C8+H8	15.780
NS 700/150 BP RoSep	35.000 L	28.500 m <sup>2</sup>	7300068529	3831116115589	7530 x 2425 x 2700-3000	2 x C8+H8; C10+H10	17.190
NS 1000/200 BP RoSep	40.000 L	40.600 m <sup>2</sup>	7300068539	3831116115596	8510 x 2425 x 2700-3000	2 x C8+H8; C10+H10	20.140
NS 1250/250 BP RoSep	45.000 L	50.800 m <sup>2</sup>	7300068549	3831116115602	9870 x 2425 x 2700-3000	2 x C8+H8; C10+H10	21.680
NS 1500/300 BP RoSep	50.000 L	61.000 m <sup>2</sup>	7300068559	3831116115619	10850 x 2425 x 2700-3000	2 x C8+H8; C10+H10	23.480

\* Note: the collection area is calculated for Murska Sobota, return period 2 years, precipitation duration 5 minutes. Use the ROTO Eco calculator for your project

Product	Code	EAN	Dim. (mm)	Price (€)
Alarm equipment for oil	7300088230	3831116128077	-	1.265
Alarm equipment for sludge	7300088240	3831116128084	-	1.925
Alarm equipment for oil/sludge	7300088250	3831116128091	-	2.266
Alarm equipment for oil/sludge/ high level	7300088260	3831116144664	-	3.014

Product	Code	EAN	Dim. (mm)	Price (€)
Pump for oil sampling	7200888141	3831116128107	-	880



Product	Code	EAN	Dim. (mm)	Price (€)
Drainage tunnel RoGea	7100088260	8058253600395	1200 x 800 x 400	70
Drainage side RoGea	7100088380	8058253600388	800 x 400	30



RoOil I. class



RoOil 10% bypass



RoOil 20% bypass



Garage oil separators

Product	Volume	Surface	Code	EAN	Dim. (mm)	Cover	Price (€)
NS 1,5 RoOil	1.200 L	60 m <sup>2</sup>	7300775949	3831116115749	Ø1300 x 1500	H6	1.150
NS 3 RoOil	1.500 L	120 m <sup>2</sup>	7300775959	3831116115756	Ø1300 x 1750	H6	1.540
NS 6 RoOil	1.700 L	240 m <sup>2</sup>	7300775979	3831116115770	Ø1300 x 2000	H6	1.890
NS 10 RoOil	2.350 L	400 m <sup>2</sup>	7300772759	3831116115701	Ø1500 x 2150	H6	2.390
NS 15 RoOil	2.700 L	600 m <sup>2</sup>	7300775999	3831116115787	Ø1500 x 2400	H6	3.020
NS 20 RoOil	4.000 L	800 m <sup>2</sup>	7300775889	3831116115732	Ø1800 x 2350	2 x H6	3.550
NS 30 RoOil	6.000 L	1.200 m <sup>2</sup>	7300772739	3831116115695	Ø2300 x 2350	2 x H6	4.720
NS 40 RoOil	7.500 L	1.600 m <sup>2</sup>	7300772789	3831116119136	Ø2300 x 2700	2 x H6	5.350
NS 50 RoOil	10.000 L	2.000 m <sup>2</sup>	7300772769	3831116115718	Ø2300 x 3400	2 x H6	6.940

Product	Volume	Surface	Code	EAN	Dim. (mm)	Cover	Price (€)
NS 15/1,5RoOil	1.500 L	600 m <sup>2</sup>	7300768829	3831116115879	Ø1300x1750	H6	1.700
NS 30/3 RoOil	1.700 L	1.200 m <sup>2</sup>	7300768909	3831116115886	Ø1300x2000	H6	2.170
NS 50/5 RoOil	2.700 L	2.000 m <sup>2</sup>	7300768979	3831116115923	Ø1500x2400	H6	3.850
NS 80/8 RoOil	3.200 L	3.200 m <sup>2</sup>	7300768989	3831116115930	Ø1800x2000	H6	4.330
NS 100/10 RoOil	4.000 L	4.000 m <sup>2</sup>	7300768929	3831116115893	Ø1800x2350	2 x H6	4.720
NS 150/15 RoOil	6.000 L	6.100 m <sup>2</sup>	7300768939	3831116115909	Ø2300x2350	2 x H6	5.620
NS 200/20 RoOil	7.500 L	8.100 m <sup>2</sup>	7300768949	3831116115916	Ø2300x2700	2 x H6	7.160

Product	Volume	Surface	Code	EAN	Dim. (mm)	Cover	Price (€)
NS 15/3 RoOil	1.500 L	600 m <sup>2</sup>	7300768809	3831116115824	Ø1300x1750	H6	2.010
NS 30/6 RoOil	1.700 L	1.200 m <sup>2</sup>	7300768819	3831116115831	Ø1300x2000	H6	2.440
NS 40/8 RoOil	2.350 L	1.600 m <sup>2</sup>	7300768969	3831116115862	Ø1500x2150	H6	2.760
NS 50/10 RoOil	2.700 L	2.000 m <sup>2</sup>	7300768509	3831116115794	Ø1500x2400	H6	3.340
NS 75/15 RoOil	4.000 L	3.000 m <sup>2</sup>	7300768889	3831116115855	Ø1800x2350	2 x H6	3.910
NS 100/20 RoOil	6.000 L	4.000 m <sup>2</sup>	7300768849	3831116115848	Ø2300x2350	2 x H6	5.670
NS 150/30 RoOil	7.500 L	6.100 m <sup>2</sup>	7300768529	3831116115800	Ø2300x2700	2 x H6	7.260
NS 200/40 RoOil	8.700 L	8.100 m <sup>2</sup>	7300768539	3831116115817	Ø2300x3000	2 x H6	10.280

Product	Code	EAN	Dim. (mm)	Price (€)
Garage oil separators, inflow/outflow DN110	7300075490	3830010987353	540 x 380 x 440	180

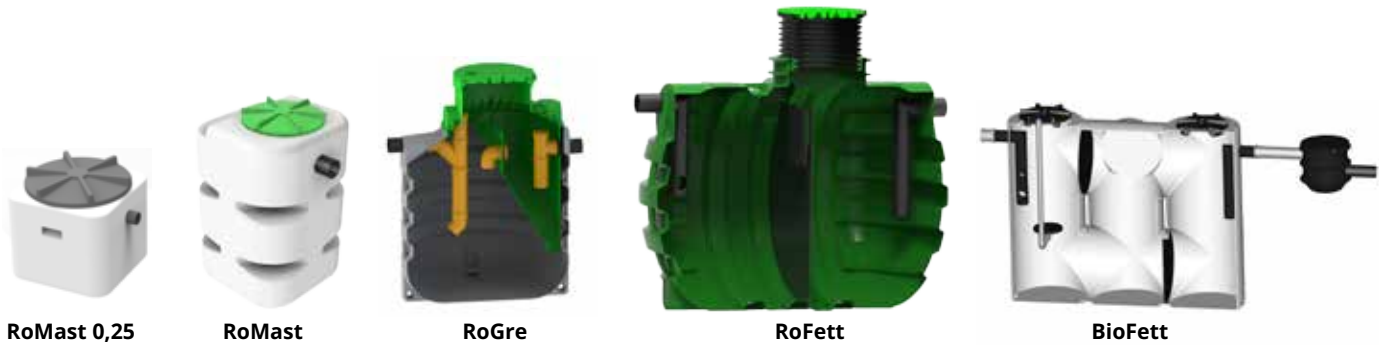

RoMast 0,25

RoMast

RoGre

RoFett

BioFett

Product	Volume	Amount of meals	Code	EAN	Dim. (mm)	Cover	Price (€)
NG 0,25 RoMast	100 L	20	7400778109	3831116115961	530 x 530 x 420	S4	180
NG 0,5 RoMast	250 L	40	7400777889	3831116115947	600 x 600 x 928	S4	500
NG 1 RoMast	500 L	80	7400777949	3831116115954	760 x 760 x 1100	S4	710
NG 2 RoMast	1.000 L	170	7400778589	3831116115978	1520 x 760 x 1150	2 x S4	820
NG 4 RoMast	2.000 L	340	7400075299	3831116119471	2250 x 750 x 1600	2 x S4	1.770

Product	Volume	Amount of meals	Code	EAN	Dim. (mm)	Cover	Price (€)
<b>NOVO</b> NG 1 RoGra	800 L	80	7400075409	3831116153345	Ø1000 x 1650	H6	820
<b>NOVO</b> NG 2 RoGra	1.000 L	170	7400075419	3831116153352	Ø1000 x 1900	H6	1.060
<b>NOVO</b> NG 4 RoGra	1.600 L	340	7400075429	3831116153369	Ø1200 x 2200	H6	1.980

Product	Volume	Amount of meals	Code	EAN	Dim. (mm)	Cover	Price (€)
NG 10 RoGre	4.000 L	850	7400775349	3831116116012	Ø1800 x 2050-2350	1 x H8	2.510
NG 15 RoGre	6.000 L	1.270	7400777969	3831116116029	Ø2300 x 2000-2300	2 x H6	2.720
NG 20 RoGre	7.500 L	1.700	7400775369	3831116128176	Ø2300 x 2400-2700	2 x H6	3.780

Product	Volume	Amount of meals	Code	EAN	Dim. (mm)	Cover	Price (€)
NG 1 RoFETT	500 L	80	7400075319	3830010987919	1330 x 860 x 1000	1 x T4	820
NG 2 RoFETT	1.000 L	170	7400075379	3830010987926	1740 x 1060 x 1020	2 x T4	1.060
NG 4 RoFETT	2.200 L	340	7400075329	3830010987070	1840 x 1400 x 1600-1900	TH6 x 4	1.980
NG 6 RoFETT	3.500 L	500	7400075339	3830010987933	2080 x 1800 x 2050-2350	TH6 x 4	2.190
NG 10 RoFETT	5.000 L	850	7400075369	3830050775323	2450 x 1800 x 2050-2350	TH6 x 4	2.830
NG 15 RoFETT	6.000 L	1.270	7400075349	3830010987940	2820 x 1800 x 2050-2350	TH6 x 4	3.040
NG 20 RoFETT	8.000 L	1.700	7400075399	3830050770212	2680 x 2300 x 2500-2880	2 x TH6 x 4	3.780
NG 25 RoFETT	12.000 L	2.120	7400777979	3831116116036	3040 x 2300 x 2500-2880	2 x TH6 x 4	6.650

Product	Code	Price (€)
Alarm equipment for feet	7300088520	1.130
Alarm equipment for feet/high level	7300088241	1.880

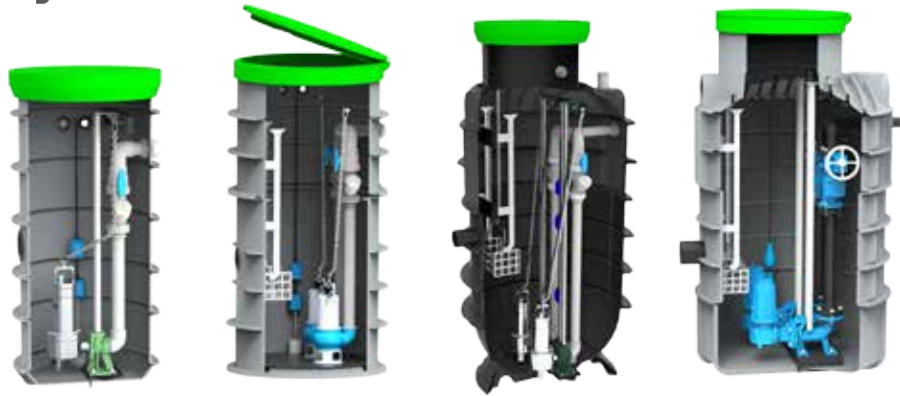

### RoPump DN600

Product	Dimensions (mm)	Cover	Code	Equipment	Price (€)
RoPump	Ø600 x 1000	H6	7700010419	Pentax DG102G	1.070
			7700010319	Pentax DG102	1.205
			7700010519	DAB FEKA VS 750 with rail and coupling kit	1.910
RoPump	Ø600 x 1200	H6	7700010709	Pentax DG102G	1.095
			7700010719	Pentax DG102	1.235
			7700010529	DAB FEKA VS 750 with rail and coupling kit	1.940
RoPump	Ø600 x 1500	H6	7700010109	Pentax DG102G	1.120
			7700010119	Pentax DG102	1.285
			7700010539	DAB FEKA VS 750 with rail and coupling kit	2.050
			7700010219	Pentax DPV 100G	930
RoPump	Ø600 x 1800	H6	7700010809	Pentax DG102G	1.260
			7700010819	Pentax DG102	1.315
			7700010549	DAB FEKA VS 750 with rail and coupling kit	2.089
			7700010229	Pentax DPV 100G	1.005

### RoPump DN800 with two pump

Product	Dimensions (mm)	Cover	Code	Equipment	Price (€)
RoPump	Ø800 x 1000	H8	7700020119	2 x Pentax DG102	2.170
			7700020519	2 x DAB FEKA VS 1000 with rail and coupling kit	3.925
RoPump	Ø800 x 1200	H8	7700020559	2 x Pentax DG102	2.190
			7700020529	2 x DAB FEKA VS 1000 with rail and coupling kit	3.950
RoPump	Ø800 x 1500	H8	7700020339	2 x Pentax DG102	2.300
			7700020539	2 x DAB FEKA VS 1000 with rail and coupling kit	4.075
RoPump	Ø800 x 1800	H8	7700020669	2 x Pentax DG102	2.315
			7700020549	2 x DAB FEKA VS 1000 with rail and coupling kit	4.130

### RoPump DN1000

Product	Dimensions (mm)	Cover	Code	Equipment	Price (€)
RoPump	Ø1000 x 2300	H8	7700030319	2 x DAB FEKA VS 1000 with rail	4.190
	Ø1000 x 2500	H8	7700030329	2 x DAB FEKA VS 1000 with rail	4.240

### RoPump DN1200 with two pump

Product	Dimensions (mm)	Cover	Code	Equipment	Price (€)
RoPump	Ø1300 x 2300	H8	7700050449	2 x Pentax DV 200	6.200
			7700020319	2 x DAB FEKA VS 1200 with rail and coupling kit	5.270

Waste water treatment plants

Water tanks

Oil separators

Grease separators

Pumping stations

Shafts

Product	Code	Price (€)
Control panel for pumping station SMART EVO 1 (230 V)	1290014	605
Control panel for pumping station SMART EVO 1 GSM	1290087	980
Control panel for pumping station SMART EVO 2 (230V)	1290015	695
Control panel for pumping station SMART EVO 2 GSM	1290088	1.010
Control panel for pumping station SMART EVO 2 3F 7,5 kW	1290089	725
Control panel for pumping station EXPRESS D2-MONO	1290090	1.270

Product	Code	Price (€)
Basket for pumping station DN600	R000285	210
Basket for pumping station DN800	R000278	295
Basket for pumping station DN1200	R000417	345
Basket attachment DN600	R000400	45
Basket attachment DN800	R000401	50

Product	Code	Dim. (mm)	Price (€)
Rail for basket DN600	R000386	height: 725 mm	185
Rail for basket DN600	R000387	height: 1025 mm	195
Rail for basket DN800	R000388	height: 725 mm	220
Rail for basket DN800	R000389	height: 1025 mm	230
Rail for basket DN1200	R000416	height: 1077 mm	340

Product	Code	Price (€)
Alarm for high level MF 220	7200088850	280
Element for PE pressure line DN 50	7200088860	60
Level sensor ET	52076	870
Floter for pumping station FLO 10m	1290016	40
Floter for pumping station FLO 20m	1290086	65

Product	Code	Dim. (mm)	Price (€)
Outside control cabinet P4	7200088310	455 x 235 x 1350	165

Product	Code	Price (€)
Start up of pumping station in Slovenia	9151038	220

Product	Code	Price (€)
RoPump Kit 1H	7700502800	490
RoPump Kit 1V	7700502801	590
RoPump Kit 2H	7700502802	610
RoPump Kit 2V	7700502803	710

## WATERMETER SHAFT without cover



Product	Cover EPS	Obod EPS	Connection	Code	Dim. (mm)	Price (€)
RoTermo shaft, without installation	✓	✓		7600521700	Ø600x1000	227
RoTermo shaft	✓	✓	3/4"	7600252070	Ø600x1000	540
RoTermo shaft	✓	✓	5/4"	7600520700	Ø600x1000	616



Product	Capacity	Isolation	Logo	Code	Dim. (mm)	Price (€)
Cover Roterme DN600, PE, for watermeter shaft	2 kN		roto	7600520690	Ø600	90
Pokrov Voda DN700, LTŽ, for watermeter shaft - assembled	15 kN	✓	voda	7612803150	Ø600	119



Product	Code	Dim. (mm)	Cover	Price (€)
Watermeter shaft, without installation	7600058080	Ø1000x1250	H6	378
Watermeter shaft, without installation	7600058400	Ø1000x1500	H6	432

## SALT BOX with cover and opening



Product	Code	EAN	Dim. (mm)	Price (€)
200 L	2100061240	3830010983683	700 × 900 × 540	191
300 L	2100061230	3830010983256	740 × 950 × 640	231
330 L	2100077380	3831116122525	1150 × 860 × 610	219
400 L	2100061200	3830010983225	750 × 1090 × 800	271
700 L	2100061520	3831116108659	1200 × 800 × 700	612
Lock RF	2734035			22

## PLASTIC URN



Product	Code	EAN	Dim. (mm)	Price (€)
URN - one	6427	3830010985571	300 × 300 × 330	30
URN - two	6428	3830010985588	470 × 300 × 330	37
URN - four	6429	3830010985595	510 × 510 × 330	56

Waste water treatment plants

Water tanks

Oil separators

Grease separators

Pumping stations

Shafts

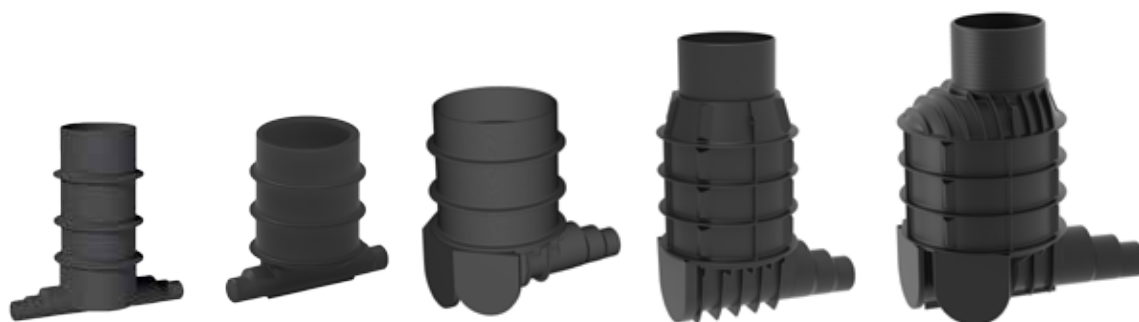

## SHAFTS

HEIGHT	160 / 200	160 / 200 / 250	calming	200 / 250 / 315	250 / 315 / 400	500 / 630	calming	160 / 200	250 / 315 / 400	500 / 600	800 / 1000
mm	DN600		DN800				DN1000				
1000	210	166	222	183	357	383	346	317			
1250	210	192	265	222	383	383	346	317	288	484	
1500	221	221	292	262	404	404	386	375	340	534	
1750	247	247	345	301	434	425	431	431	392	574	
2000	274	289	404	340	446	446	562	479	445	626	751
2250		321	449	379	467	467	614	546	497	684	798
2500		355	471	475	488	488	675	604	604	781	892
2750			516	541	548	548	725	670	670	854	1.031
3000			610	608	618	618	780	735	735	939	1.147
3250									800	1.027	1.245
3500									871	1.123	1.371
3750									935	1.229	1.537
4000									1.000	1.317	1.687
4250									1.067	1.411	1.822
4500									1.174	1.493	1.969
4750									1.267	1.572	2.111
5000									1.337	1.670	2.241

## SAND SHAFTS

HEIGHT	sand shaft	sand shaft	sand shaft	sand shaft	sand shaft	sand shaft
mm	DN400	DN500	DN600	DN800 with opening	DN800	DN1000
1000	98	140	166	222	210	
1250	100	150	192	265	240	281
1500	101	163	202	292	270	326
1750			225	345	292	376
2000			270	404	368	421
2250			326	449	414	551
2500			360	471	451	607
2750						685
3000						775



**CONNECTORS**



Product	Code	Price €
OD 160	5879	37
OD 200	5874	56
OD 250	5875	63
OD 300	5868	68
OD 400	5869	81
OD 500	5866	101
OD 600	5767	126
OD 800	5877	290
OD 1000	5878	428
OD 1200		541

**CONNECTORS**



Product	Code	Price €
ID 160		37
ID 200	5750	56
ID 250	5751	63
ID 300	5752	68
ID 400	5753	81
ID 500	5754	101
ID 600	5755	126
ID 800	5756	290
ID 1000	5876	428

**STAIRS**



Product	Code	Price €
PE stair	1280017	34
Integrated PE ladder	1280015	17

Waste water treatment plants

Water tanks

Oil separators

Grease separators

Pumping stations

Shafts

## FLANGED CONNECTION



Product	Code	Price €
Flanged connection DN250 d250, PE	7100291550	350
Flanged connection DN300 d315, PE	7100291560	495
Flanged connection DN200 d200, PE	7100291540	290
Flanged connection DN150 d160, PE	7100291530	180
Flanged connection DN125 d140, PE	7100291520	125
Flanged connection DN100 d110, PE	7100291510	100
Flanged connection DN80 d90, PE	7100291500	90
Flanged connection DN65 d75, PE	7100291490	80
Flanged connection DN50 d63, PE	7100291480	70

## CONNECTORS



Product	Code	Price €
Connection DN50, PE	1202000	21
Connection DN63, PE	1202001	21
Connection DN75, PE	1202002	22
Connection DN90, PE	1202003	24
Connection DN110, PE	1202004	27
Connection DN125, PE	1202005	28
Connection DN160, PE	1202006	37
Connection DN200, PE	1202007	43
Connection DN250, PE	1202008	52
Connection DN300, PE	1202009	66
Connection DN400, PE	1202010	86
Connection DN500, PE	1202011	135

## RUBBER SEAL



Product	Code	EAN	Price €
Inflow seal for pipe Ø50	1280302	3831116163283	10
Inflow seal for pipe Ø63	1290021		10
Inflow seal for pipe Ø75	1280454	3831116163351	11
Inflow seal for pipe Ø90	1202012		12
Inflow seal for pipe Ø110	1280304	3831116163306	13
Inflow seal for pipe Ø125	1280305	3831116163313	14
Inflow seal for pipe Ø160	1280303	3831116163290	16
Inflow seal for pipe Ø200	1280306	3831116163320	20
Inflow seal for pipe Ø250	1280307	3831116163337	23
Inflow seal for pipe Ø300	1280312	3831116163344	25
Inflow seal for pipe Ø400	1280705	3831116163368	32

ROTO SLOVENIJA d.o.o. (hereinafter referred to as ROTO) sells and delivers the Products exclusively in accordance with these General Terms and Conditions of Business, which are published on the website [www.rotoECO.eu](http://www.rotoECO.eu), unless otherwise specified in writing in advance for individual Products. Any deviations from these General Terms and Conditions shall only be valid by written agreement.

### 1. Prices

The price list is valid from 1.1.2022.

We reserve the right to change prices and terms and conditions of sale.

All prices in the catalogues are exclusive of value added tax (VAT) in euros.

Any price increases on the market may change the prices in the price list. In the absence of major market changes, prices are valid for as long as the catalogue is valid. Changes due to unforeseen events are possible and we are therefore bound by the prices quoted in the quotation or order confirmation. In the event of extraordinary price increases on the raw materials market, we reserve the right to change the prices in the price list without prior notice. All prices of the old price list shall cease to be valid upon the issue of the new price list.

### 2. Dimensions, volumes and weights

The information on the dimensions, weights, properties, load capacity and capacity of the products in our price list correspond to general norms and are valid as long as we do not change them in writing. The information given may vary slightly from actual values. Printing errors cannot be excluded.

### 3. Packaging

We endeavour to keep packaging costs low and to ensure that packaging offers sufficient protection for products and is environmentally friendly. For products where packaging is not strictly necessary, we do not use packaging. Packaging and pallet prices are charged according to the current price list.

### 4. Delivery time

The delivery period shall be deemed to run from the date of confirmation of the order by the Supplier until the goods are handed over to the Buyer. The approximate delivery time for the products is indicated on the quotation. Delivery times shall not apply to orders of larger quantities. We accept liability for any delays only in the event of our own negligence. We shall not be liable for delays caused by suppliers, extraordinary circumstances, force majeure, etc.

### 5. Technical advice

The ROTO Technical Service will be happy to assist you in selecting suitable clean and wastewater solutions and in preparing the project documentation for each project, or you can use the ECO CALCULATOR on our website. We also offer on-site consultancy, presence at installation, commissioning, maintenance and servicing of ROTO products. We can tailor the products to the individual project and carry out a turnkey project. Installation and maintenance instructions are available at [www.rotoECO.eu](http://www.rotoECO.eu).

### 6. Payment method

We reserve the right to require different payment terms at our discretion. Payment terms are agreed in writing in the quotation. We reserve the right to require insurance instruments (e.g. a bank guarantee) as security for payment within a time limit agreed in writing. The discount is only possible on the products and does not apply to packaging, transport or assembly. In the event of payment after the due date of the invoice, we may charge statutory late payment interest. We reserve the right to hold all goods handed over to ROTO until full payment for the goods has been made. In the event of failure to remind us, we reserve the right to reclaim the goods issued at the expense of the purchaser.

### 7. Assembly, installation

Prices do not include installation and assembly in the field. If installation is agreed, it shall be carried out in accordance with the applicable written terms and conditions and the quotation agreed in advance. We have the right to involve subcontractors.

### 8. Delivery

The cost of delivery of the goods to the customer is not included in the price of the product and shall be charged to the customer according to the prior written quotation and conditions, the applicable ROTO price list or the price list of the transport company. If delivery is not possible to the desired location, the Buyer must notify us in writing at least 3 days in advance. The handing over of the goods to the Buyer completes and finalizes the sales process and all liability shall be transferred to the Buyer. Upon acceptance, the Buyer is obliged to check the quality and quantity of the Goods. Any discrepancies should be noted immediately on the delivery note, which should be forwarded immediately to ROTO Logistics. Otherwise, we will not accept the complaint.

### 9. Warranty

The warranty period is 60 months for the durability and watertightness of the container, 24 months for the durability and functioning of the technical parts. The warranty is subject to the presentation of a complaint invoice. The guarantee period starts from the date of purchase.

### 10. Data protection

The Customer expressly authorises us to store, process and use the personal data made available to ROTO. ROTO undertakes to protect the personal data in accordance with the "Personal Data Protection Act (PDPA)" and to process and use them only in connection with the exercise of the rights and obligations arising from the contractual relationship and for advertising and marketing purposes.



ROTO Slovenija d.o.o.  
Puconci 12  
9201 Puconci  
Slovenia  
eco@roto.si  
+386 2 52 52 168

[WWW.ROTOECO.EU](http://WWW.ROTOECO.EU)